

Sunview Led



Next Gen Post Top Led

SRHPT SERIES



RoHS



Ideal for parking lot, playground, square, park, highway, greenbelt
golf course, and etc.

www.sunviewled.com / info@sunviewled.com / T:+1 877778-6843

1

Feature

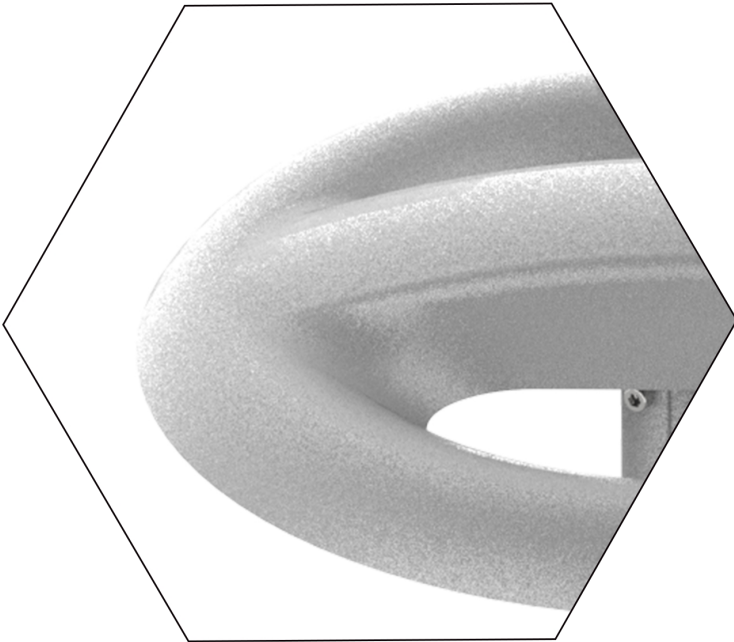

▶ **Unique Design**

Decorate your public space

▶ **Hydrophobic surface**

Too smooth to gather any dirt

▶ **Rust resistant**

All aluminium body

▶ **Highly Efficient System**

160Lm/w lighting output

▶ **IP66**

Integrated design protect the light from water & dirt

▶ **High robustness**

Provide long-term lighting

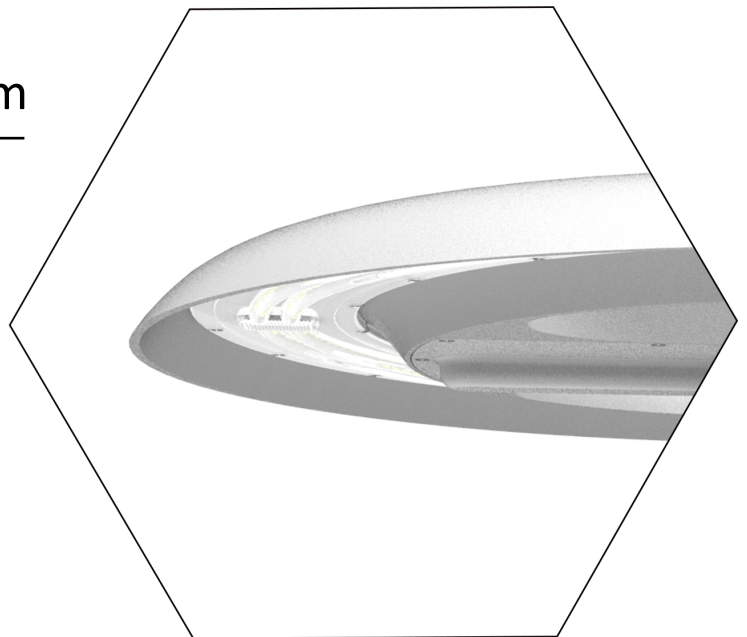

2

Parameters

WATTAGE	50/80/100/150/200/240W
DRIVER	MEANWELL
LAMP EFFICIENCY	160LM/W \pm 5%
LIGHT SOURCE	LUMIEDS
CRI	Ra>70/80
CCT	2700-6500K
RATED VOLTAGE	AC 100-240V 277V~,50/60Hz
POWER FACTOR	>0.95
BEAM ANGLE	60°/90°/120°
IP GRADE	IP66
OPERATING TEMP	-40°C~60°C
POLE SIZE	60/80mm

SRHPT-50W

8,000LM \pm 5%
3.6kg \pm 5%
 ϕ 380*162mm

SRHPT-80W

12,800LM \pm 5%
4.0kg \pm 5%
 ϕ 380*162mm

SRHPT-100W

16,000LM \pm 5%
4.1kg \pm 5%
 ϕ 380*162mm

SRHPT-150W

24,000LM \pm 5%
4.2kg \pm 5%
 ϕ 380*162mm

SRHPT-200W

32,000LM \pm 5%
6.0kg \pm 5%
 ϕ 500*168mm

SRHPT-240W

38,400LM \pm 5%
6.0kg \pm 5%
 ϕ 500*168mm

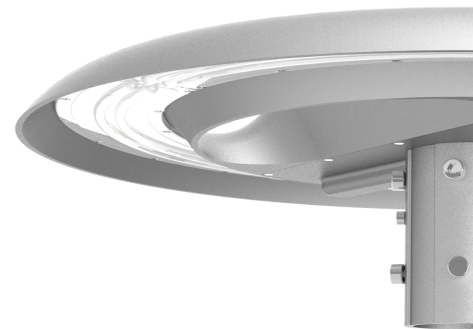

3

Application



1. Unique appearance, stylish decoration for your public space.

2. Annular luminous surface, efficient and comfortable lighting.

3. All aluminum body resists corrosion and age well.

4. Smooth curve surface gather no dirt/leaf/snow/ice, self-cleaning with the assistants of wind and rain.

4

Testing

- Temperature Rise Test

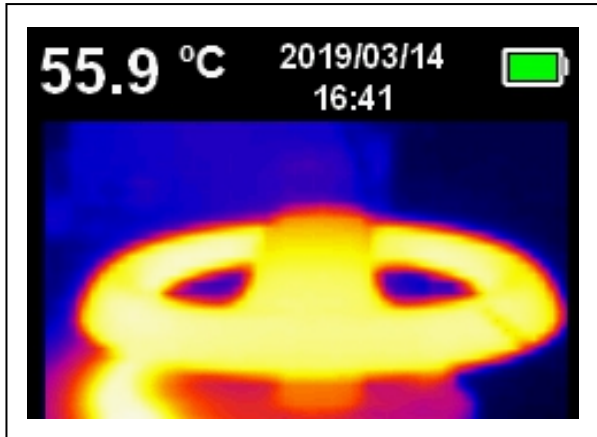

- Salt Spray Test

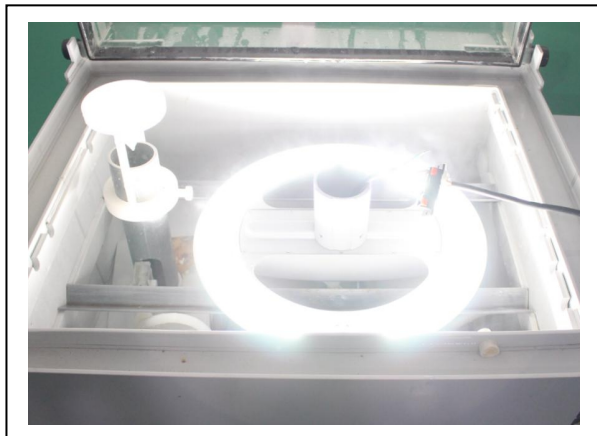

- Vibration Test

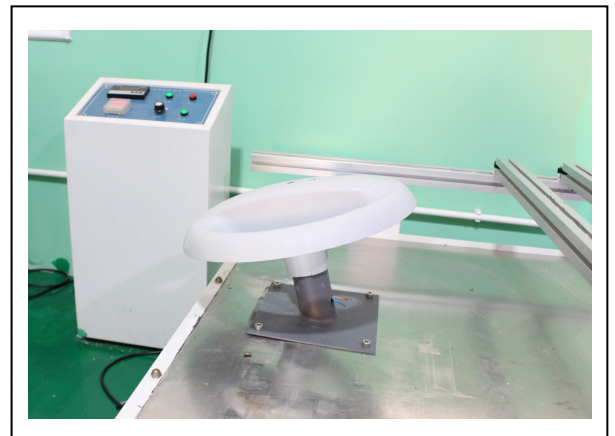

- Withstand Voltage Test

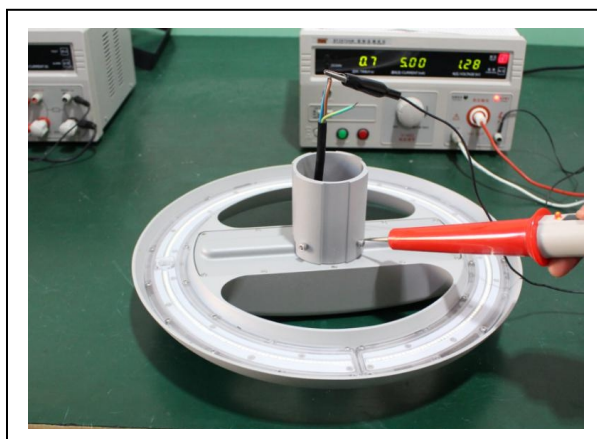

- High-Low Temperature Test

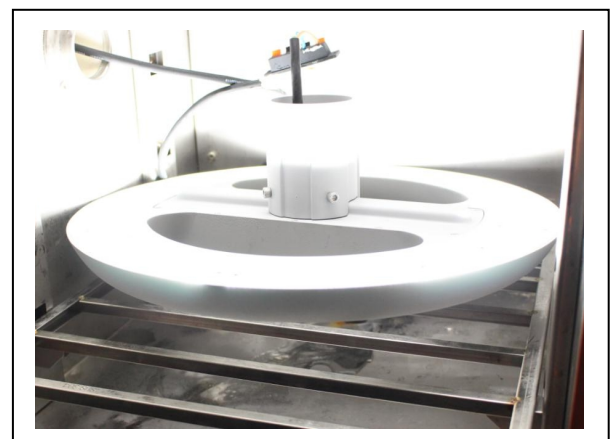

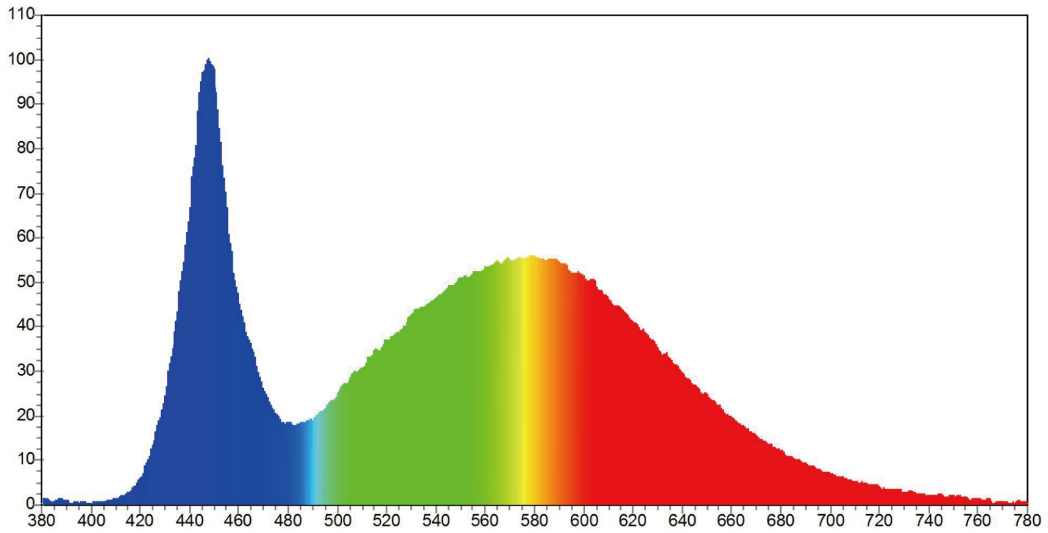

Spectrum Parameters					
x: 0.3393	y: 0.3504	R1: 80.1	R2: 84.8	R3: 85.7	
u: 0.2080	v: 0.3221	R4: 80.1	R5: 80.1	R6: 76.1	
WD: 566.5 nm	WP: 447.5nm	R7: 81.8	R8: 67.3	R9: 7.1	
HW: 23.0 nm	Purity: 0.069	R10: 60.8	R11: 78.2	R12: 58.8	
CCT: 5224 K	Ra: 79.5	R13: 80.0	R14: 91.6	R15: 77.8	
DUV: 0.0018		R%: 26.9	G%: 43.1	B%: 30.0	
Kred 18.71%	Kgreen 76.09%	Kblue 5.20%			
Electrical					
Flux: 31838.798 lm		P: 158.797 lm/w		P: 4247.19 mw	
I: 906.4 mA		V: 221.20 V		P: 200.5 w	
PF: 0.9650					

5 Light Distribution

60° / 90° / 120° available

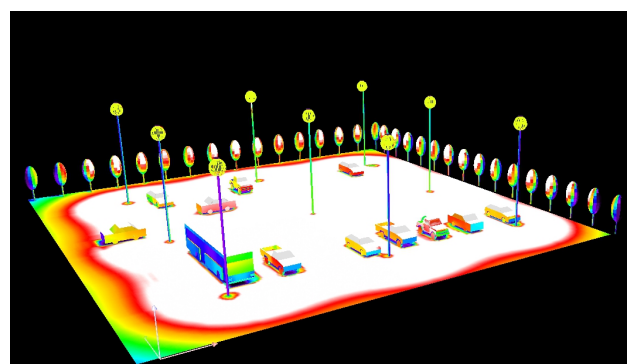
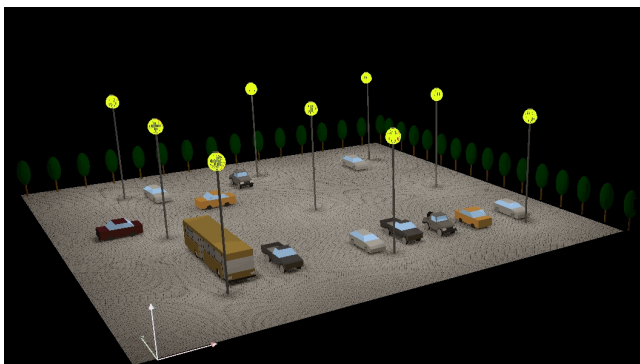
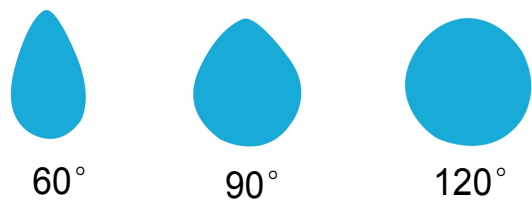

6

Package

Type A: 380mm series

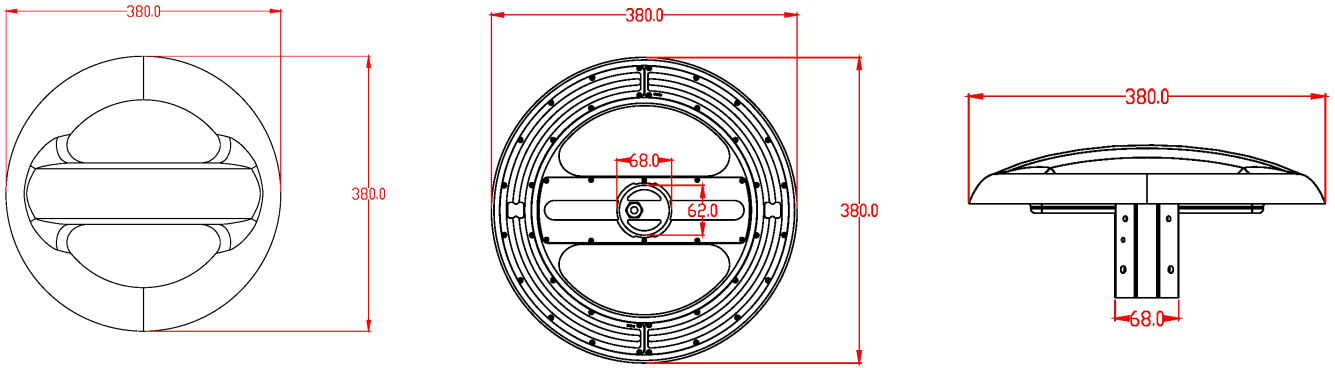

Wattage	Net Weight	Size of Box	Cross Weight	Size of Carton	Gross Weight	Box Quantity / Carton
SRHPT-50W	3.6kg ± 5%	44x43x19cm	6.0kg ± 5%	45x45x77cm	22.5kg ± 5%	4
SRHPT-80W	4.0kg ± 5%	44x43x19cm	6.0kg ± 5%	45x45x77cm	24.0kg ± 5%	4
SRHPT-100W	4.1kg ± 5%	44x43x19cm	6.5kg ± 5%	45x45x77cm	24.5kg ± 5%	4
SRHPT-150W	4.2kg ± 5%	44x43x19cm	6.5kg ± 5%	45x45x77cm	24.5kg ± 5%	4

Type B: 500mm series

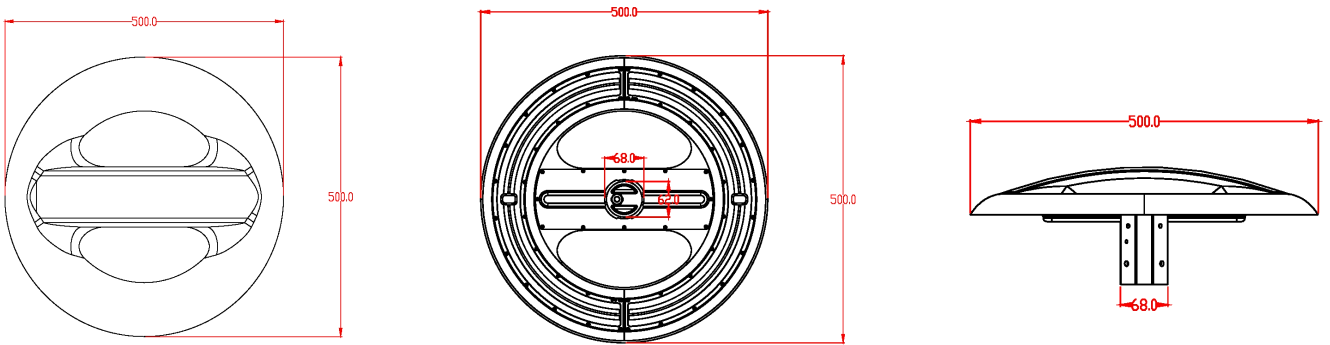

Wattage	Net Weight	Size of Box	Cross Weight	Size of Carton	Gross Weight	Box Quantity / Carton
SRHPT-200W	6.0kg ± 5%	57x57x20cm	9.0kg ± 5%	58x58x79cm	36.0kg ± 5%	4
SRHPT-240W	6.0kg ± 5%	57x57x20cm	9.0kg ± 5%	58x58x79cm	36.0kg ± 5%	4

